

**Dimensions:** 1250 x 625 x 120 mm (LxWxH) with a dimensional tolerance of max. 3 mm

**Color:** Deer grass pavers undergo a slight color change due to influences such as sunlight and weather conditions, after which the tile retains its authentic shade during its lifetime.

**Structure:** the grass pavers must have sufficient stiffness to prevent slipping. The surface structure is untreated.

For better walkability, part of the grass paver is without openings (625 x 341 mm). The grass paver is composed of 5 rectangular longitudinal beams that are 1250 mm long and 62.5 mm wide on the top surface. The beams converge conically towards the bottom surface to a width of 74.5 mm. These beams are connected by 3 lowered cross beams that are 80 mm high and 80 mm wide.

The center distance between the longitudinal beams is 125 mm, between the cross beams 250 mm. The slit between the longitudinal beams measures 62.5 mm on the top surface, because the longitudinal beams to the bottom surface converge conically widens the slit to 50.5 mm

**Load class:** BC5 - limited heavy traffic (according to PTV-126), suitable for light traffic, parking, occasional heavy traffic, highways, road widening. The characteristic load at 2 supports for BC5: 40 (N / mm).

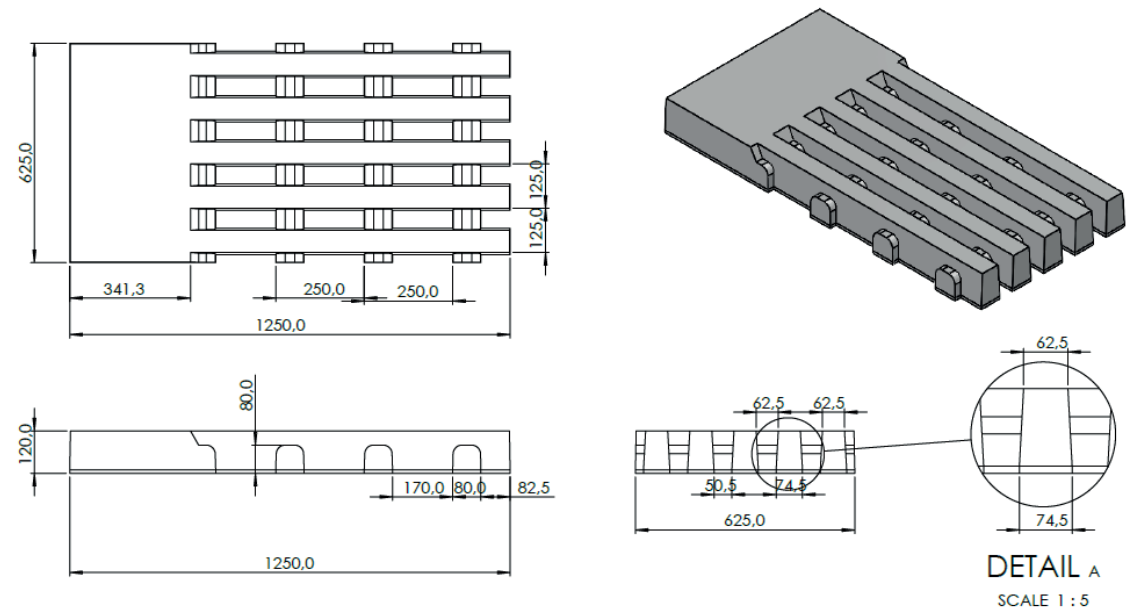

**Foundation:** continuous crushed stone 0/40 (type 1 according to SB 250) with thickness 30 mm

**Strength class:** C45/55 and is made with a limestone beat granulate for better durability.

**Water absorption:** max 5%

**Steel quality:** BE500ES

**Rounding:** > 25mm

**Weight:** 165 kg/st (211 kg/m<sup>2</sup>)

The grass pavers must harden in one for at least 24 hours closed damp room.

**Drainage opening:** 18.2%

**Lawn opening:** 36.4%

**Fill volume:** 30.3 L/m<sup>2</sup>. The grass pavers can be filled with broken crushed stone or a grass concrete mixture.

#### Technical specifications detail:

- Actual breaking load: minimum 1000 kg
- Suitable as water-permeable hardening
- Suitable as grass growth hardening
- Natural stone impact (1500 kg/ m<sup>3</sup>): 45.5 kg/m<sup>2</sup>
- Grassy substrate (500 kg/m<sup>3</sup>): 15.2 kg/m<sup>2</sup>

## Delivery & placement

The grass pavers must be delivered on pallets without wooden spacers that leave traces on the pieces. A good alternative can be nylon rope or plastic spacers.

The placement is done with a lifting clamp for grass concrete tiles or a custom stone clamp for which two options are possible:

1. Stone clamp with metal bars that fit in the openings
2. Stone clamp equipped with plates of preferably 8 mm between which the grass pavers are clamped

Fine positioning can be done with a rubber hammer.

You have the option to provide the lifting clamp yourself, or you can rent a lifting clamp from Deer. Below is an example of a lifting clamp for grass concrete tiles:

